

Output

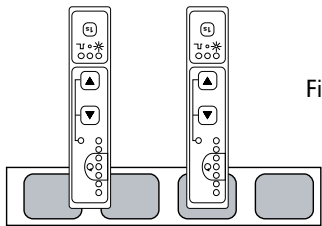
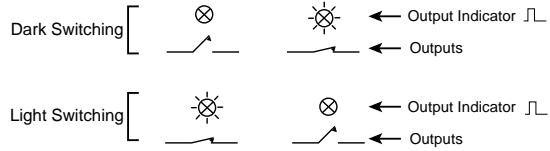
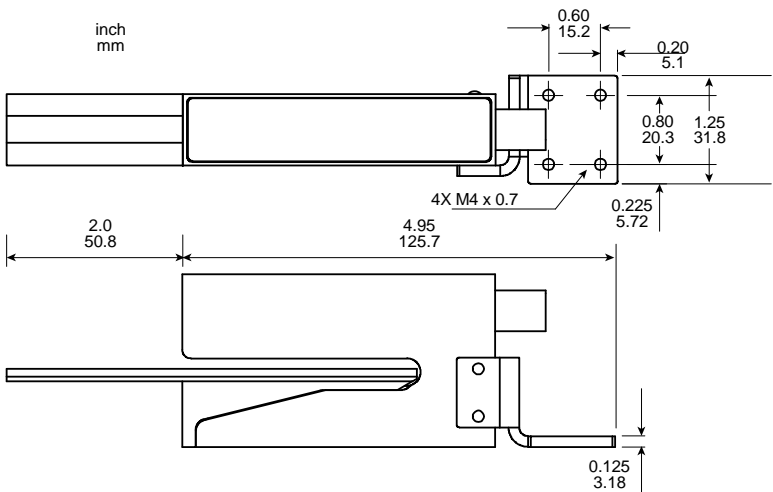
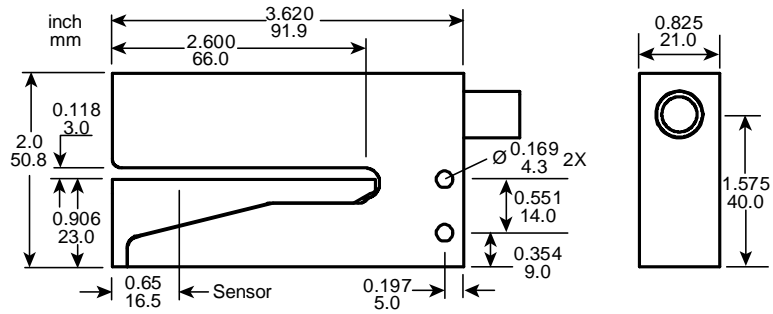

Fig. 3



Mechanical Detail



Two-Year Warranty details at: www.lionprecision.com/warranty.html

User's Guide
 for the
LRD8200 Label Sensor
 from
Lion Precision

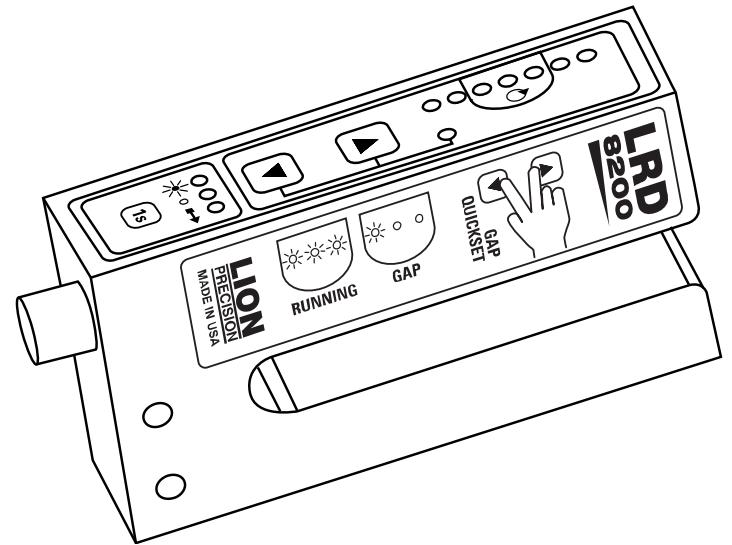

Lion Precision
 563 Shoreview Park Road
 St. Paul, MN 55126
 651-484-6544
www.lionprecision.com
 Document Number: M016-6100.005



Description

The Lion Precision LRD8200 Label Sensor uses ultrasonic technology to monitor label registration and/or count labels. A change in the sensor output indicates the presence of a label edge.

Connecting to the Sensor

Warnings:

Sensors must not be attached to voltages in excess of 30 VRMS or 60 VDC

All external connections must be SELV (Safety Extra Low Voltage). A shielded cable is required for full protection and safety compliance.

All power must be off when installing the sensor.

Use of the equipment in any other manner may impair the safety and EMI protections of the equipment.

If outputs are overloaded, all indicators on the sensor will flash together and sensor will stop operating. Normal operation will be restored when the overload is removed.

Wire Color	Connection	Notes
1 (Brown)	Vin (12-24 V _{DC})	50 mA max.
2 (White)	NPN Output	150 mA max.
3 (Blue)	Ground	Connected to sensor body
4 (Black)	PNP Output	150 mA max.
Shield	Ground	Sensor Case
Any other wires in the cable (if using 5 wire) are not connected in the sensor and can be ignored.		

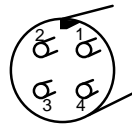
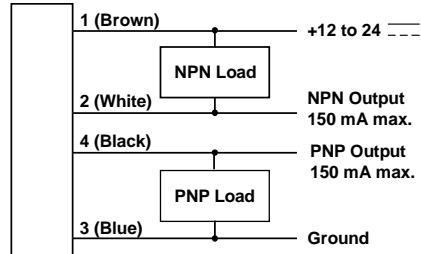

M12 connector on rear of sensor

Specifications

Power supply	Voltage	12-24 V _{DC} (reverse polarity protected)
	Current	50 mA
Response time	On or Off	125-425 μ s max
	Switching Frequency	1 kHz max, 250 m/min for 2mm gaps
Output	Output Current (sinking or sourcing)	150 mA max (overload protected)
	Switching output	PNP (sourcing) or NPN (sinking), Dark or light switching
	Registration Accuracy	60 m/min: 0.15 mm (0.006") 250 m/min: 0.60 mm (0.024")
Temperature	Operating Range	40°F to 140°F (4°C to 60°C)
Protections	Supply	Inverse Polarity Protection
	Switching output	Short Circuit and Overload Protection

Sensor Setup

- Labels must pass under the "Sensing Area" indicator (see fig. 1).
- Place a gap in the sensor (or remove a label and place the liner only in the sensor)
- Press both Adjust buttons at the same time to quickly set the sensor, or...
 - Manually use Adjust buttons to light the "Gap Setup" light on the light bar (see fig. 1, 2).
- Run labels through the sensor to verify that the three "Running" lights (see fig. 1, 2) are active (on or flashing) while labels are passing through the sensor. If not, use Adjust buttons until they are. More lights than the three "Running" lights may be active while running labels.
- If sensor is not performing satisfactorily, adjust up and/or down a few clicks and see if performance improves, but always keep the three Triple-Check lights on when running.

For best performance, web must remain in contact with the base plate.

Light/Dark Switching

Light/Dark switching mode (see Fig. 3) is displayed by the Light/Dark Indicators (see fig. 2).

To change between light and dark switching, hold the Light/Dark Select ("1S") button for 1 second.

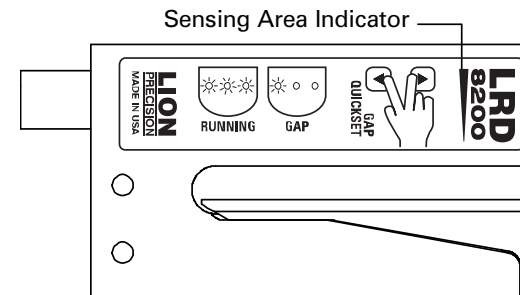

Fig. 1

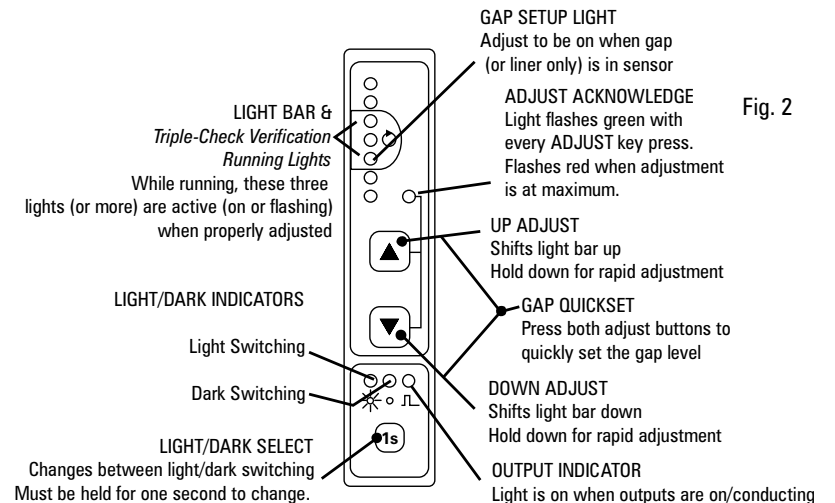

Fig. 2