

# INSTRUCTION MANUAL

---

## ECL150/ECL150e Eddy-Current Displacement Sensor

Measurement Systems  
from  
LION PRECISION

# Approvals and Safety Considerations

---

The ECL150 and ECL150e are compliant with the following CE directives:

2006/95/EC (Low Voltage Directive)  
2004/108/EC (EMC)

as validated using the following standards:

Safety: 61010-1:2001  
EMC: 61326-1, 61326-2-3

To maintain compliance with these standards, the following operating conditions must be maintained:

- All I/O connecting cables must be less than three meters in length
- AC power cables must be rated at a minimum of 250 V and 5 A
- AC power must be connected to a grounded mains outlet rated less than 20 A
- Power supply must have CE certification and provide safety isolation from the mains according to IEC60950 or 61010.
- Sensors must not be attached to parts operating at hazardous voltages in excess of 30 VRMS or 60 VDC
- All external connections must be SELV (Safety Extra Low Voltage).

Use of the equipment in any other manner may impair the safety and EMI protections of the equipment.

## ECL150 and ECL150e

---

The ECL150e is identical to the ECL150 except that resolution is limited to a best case of 0.3  $\mu\text{m}$ . For this reason, the ECL150e does not require an export license. For details on export restrictions, please refer to [www.lionprecision.com/export.html](http://www.lionprecision.com/export.html).

This manual will only refer to the ECL150, but all instructions apply to the ECL150e.

## Description

---

The Lion Precision ECL150 Eddy-Current Displacement Sensor provides up to eight channels of high-resolution, noncontact displacement measurement of a conductive target. The system consists of driver electronics and probes calibrated for a specific material, range, and ECL150 channel. The ECL150 provides linear  $\pm 5$  V outputs for each channel; more positive output voltage indicates the probe is further from the target. The calibration information is detailed on a calibration certificate which is shipped with the system.

## Quick Start Instructions

---

1. Connect the probes to the matching channels on the ECL150.

Each channel is calibrated to a specific probe identified by a channel number marker on the probe cable. The probe serial numbers are listed on the labels on the end of the electronics enclosure.
-----------------------------------------------------------------------------------------------------------------------------------------------------------------------------------------------------

2. Connect the output to a monitoring device.
3. Connect, then apply, power.
4. Adjust the probe position so the Range Indicator shows green

## LED Range Indicator

---

The Range Indicator monitors and displays the probe position within its calibrated range. The indicator is green when the probe is in the calibrated range and red when out of the calibrated range. If the Range Indicator is red, the output voltage is not a reliable measurement.

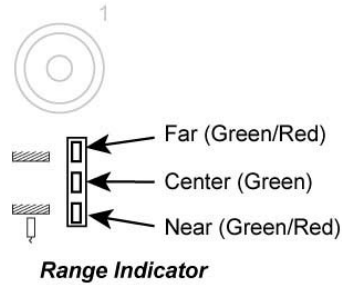

## Analog Output Signals

---

Each channel's output signal is a  $\pm 5$  VDC analog voltage. The output voltage is proportional to the probe-target gap. As the probe-target gap increases, the voltage becomes more positive. See the included calibration certificate for specific information.

### Interpreting the Output Voltage

Output voltage change for a given change in the probe-target gap is called *sensitivity*. The sensitivity of the sensor is listed on the calibration certificate.

*Change in gap calculation:*

**Gap Change = Voltage Change / Sensitivity**

For example: With a sensitivity of  $1\text{V}/2\ \mu\text{m}$  and a voltage change of  $+3\ \text{V}$ , the probe-target gap has increased by  $6\ \mu\text{m}$ .

## Probe Mounting

---

When multiple probes are mounted together, they must be separated by at least 3 probe diameters to prevent interference between the channels. The area within 3 probe diameters to the sides and 1.5 diameters behind should be kept clear of any metallic objects other than the object to be measured. Otherwise, custom calibration will be required.

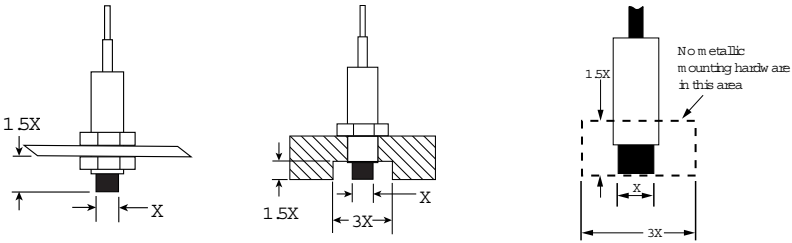

## Extension Cables

---

Sensors which are calibrated with a probe extension cable must be operated with the extension cable installed to meet specifications. Operating without the extension cable will result in inaccurate measurements.

## Ungrounded Targets

---

Ungrounded targets have the potential to inject noise into the sensor. If the output is unusually noisy, be sure the target is grounded. On moving/rotating targets this can be accomplished with a small metal brush or thin piece of metal which is connected to ground.

## Multiple Systems

---

All channels within the ECL150 are synchronized and can be used on the same target. When multiple ECL150s are used with the same target, the systems must be synchronized for best performance. An interconnecting cable connects between the Sync In and Sync Out connectors. Single systems do not come with these connectors installed.

# Setting Bandwidth

The system is shipped with the bandwidth setting listed on the calibration certificate based on order specifications. To change bandwidth, remove the I/O connector endplate and set switches according to the table below. Bandwidth specifications are -10%/+30%.

SW1	SW2	Bandwidth
Up	Up	250 Hz
Down	Up	1 kHz
Up	Down	10 kHz
Down	Down	15 kHz

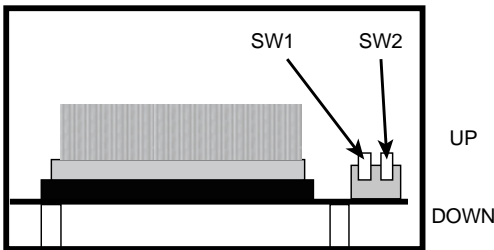
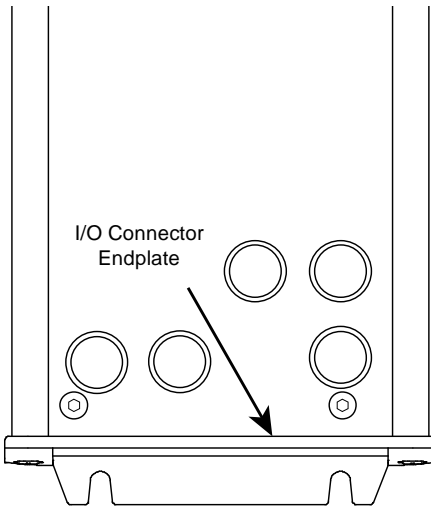

# Connecting to the ECL150

The ECL150 is shipped with all required connecting cables. Power and Output connecting cables are terminated with an M12 device connector at one end and color-coded wires at the other end.

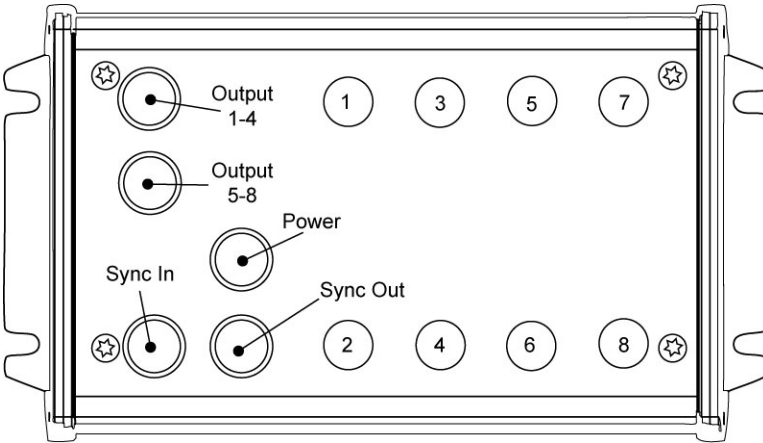

## Power Connections

Device Connector: 4-Pin, M12, Male Power Cable PN: 6203-0400			
Pin	Wire Color	Connection	
1	Brown	12 to 24 VDC	Internally Connected
2	White	12 to 24 VDC	
3	Blue	Power Ground	Internally Connected
4	Black	Power Ground	

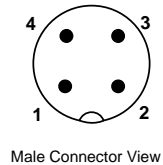

## Sync Connections

*Sync connectors are only installed when multiple systems are sold together.* Connect a sync cable (Lion Precision Part Number 6203-0820) from the SYNC OUT of one system to the SYNC IN of the other system. Using multiple systems with the same target without synchronization will result in decreased performance.

### Output 1-4 Connections

Device Connector: 8-Pin, M12, Female Output Cable PN: 6203-0810		
Pin	Wire Color	Connection
1	White	Ch1 Out
2	Brown	Ground
3	Green	Ch2 Out
4	Yellow	Ground
5	Gray	Ch3 Out
6	Pink	Ground
7	Blue	Ch4 Out
8	Red	Ground

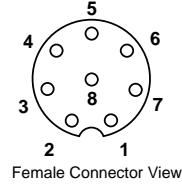

### Output 5-8 Connections

Device Connector: 8-Pin, M12, Female Output Cable PN: 6203-0810		
Pin	Wire Color	Connection
1	White	Ch5 Out
2	Brown	Ground
3	Green	Ch6 Out
4	Yellow	Ground
5	Gray	Ch7 Out
6	Pink	Ground
7	Blue	Ch8 Out
8	Red	Ground

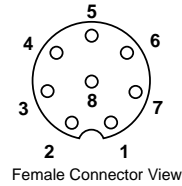



## Specifications

Parameter		Specification	Notes
Power Requirement		12 to 24 VDC, 1-2 Channels – 2.5 W 3-4 Channels – 3.5 W 5-6 Channels – 4.5 W 7-8 Channels – 5.5 W	
Resolution RMS @15 kHz (Typical) <sup>1,2</sup>	nonferrous	ECL150: 0.006 to 0.008%F.S. ECL150e: 0.3 μm or higher <sup>3</sup>	See calibration sheet for specifics
	ferrous	ECL150: 0.007 to 0.1%F.S. ECL150e: 0.3 μm or higher <sup>3</sup>	
Linearity <sup>1</sup>		±0.2%F.S.	
Error Band <sup>1</sup>		±0.4%F.S.	
Analog Output <sup>1</sup>		±5 VDC, 0 Ω, 15 mA max	
Analog Output Update Rate		15 μS	
Driver Operating Environment		4°C-50°C, IP64	
Probe Operating Environment	Standard Probes	-25°C to +125°C, IP67	
	High Temp. Probes	-25°C to +200°C, IP63	

<sup>1</sup>Actual values depend on probe and range and are listed on the calibration certificate shipped with the product. Contact Lion Precision for replacement certificates.

<sup>2</sup>In High EMI environments (10 V/m), output noise levels may rise to 60 mV (0.6% resolution) and DC level may shift by 0.2 VDC.

<sup>3</sup> The ECL150e is identical to the ECL150 except that resolution is limited to a best case of 0.3 μm. For this reason, the ECL150e does not require an export license. For details on export restrictions, please refer to [www.lionprecision.com/export.html](http://www.lionprecision.com/export.html).

**Specifications Continued**

Parameter	Specification		Notes	
Temperature Coefficient (Driver) ±% F.S./°C	nonferrous	U3 Probe	0.04	Over 15°C to 50°C temperature range
		U5 Probe	0.1	
		U8 Probe	0.04	
		U12 Probe	0.01	
		U18 Probe		
		U25 Probe		
		U38 Probe		
		U50 Probe		
	ferrous	U3 Probe	0.08	
		U5 Probe	0.10	
		U8 Probe	0.04	
		U12 Probe	0.01	
		U18 Probe		
		U25 Probe		
		U38 Probe		
		U50 Probe		

### Specifications Continued

Parameter	Specification		Notes	
Temperature Coefficient (Probe) $\pm\%$ F.S./ $^{\circ}\text{C}$	nonferrous	U3 Probe	0.04	Over 15 $^{\circ}\text{C}$ to 65 $^{\circ}\text{C}$ temperature range except where noted.
		U5 Probe	0.04	
		U8 Probe	0.02	
		U12 Probe	0.02	
		U18 Probe	0.01	
		U25 Probe		
		U38 Probe		
		U50 Probe		
	ferrous	U3 Probe	0.08	
		U5 Probe	0.10	
		U8 Probe	0.04	
		U12 Probe	0.03	
		U18 Probe	0.01	
		U25 Probe		
		U38 Probe		
		U50 Probe		

# Mechanical Detail

---

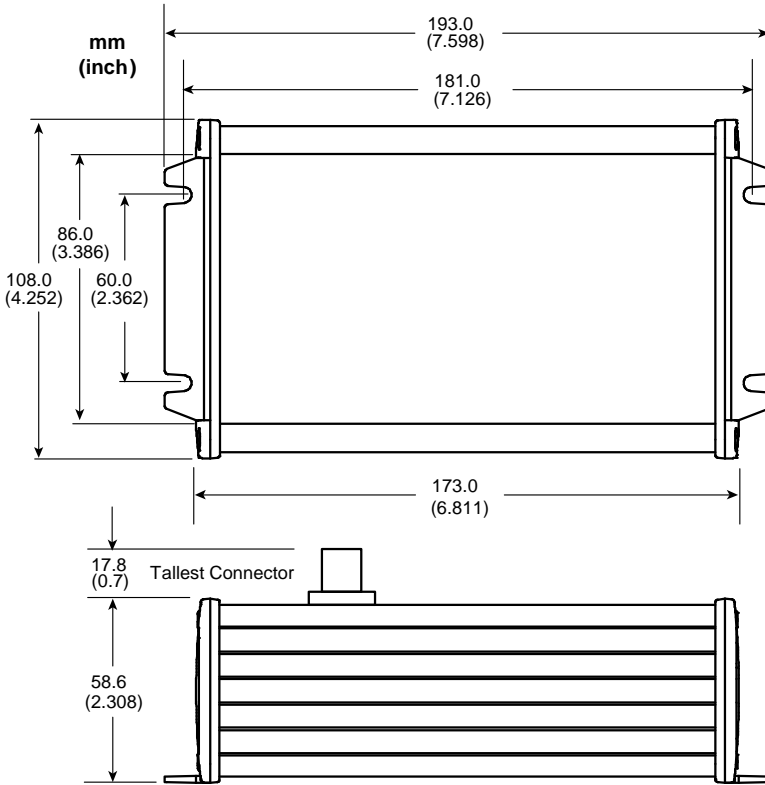

## Power Supply

Power In: 100-240 VAC 50-60 Hz

Power Out: 12 VDC @ 1.5 A (18 W)

CE and UL registered

